

# DIMENSIONS

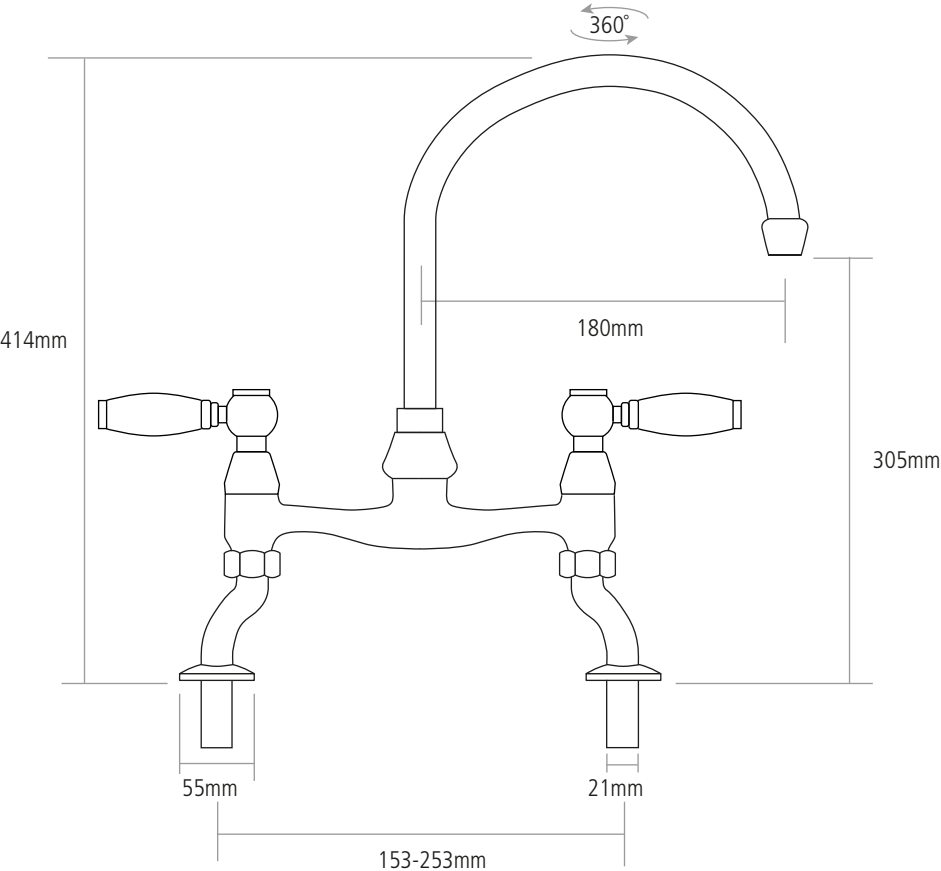

Worktop cut-out 25mm required