

**Serie | 8, Built-in washing machine, 8 kg, 1400 rpm
WIW28501GB**



Especially quiet washing machine with EcoSilence Drive and Silence program: enjoy very quiet operation and excellent durability.

- **EcoSilence Drive™:** quiet and energy-efficient drive, with a 10-year warranty.
- **VarioDrum:** gentle washing thanks to a unique drum structure.
- **ActiveWater Plus:** For highly efficient use of water even with smaller loads thanks to automatic load detection.
- Easy-to-use LED display with touch control and many additional functions like start delay and remaining time.
- **Reduced noise wash:** Programme option for extremely quiet washing.

Technical Data

Energy Efficiency Class: C

Weighted energy consumption in kWh per 100 washing cycles of eco 40-60 programme: 62 kWh

Maximum capacity in kg: 8.0 kg

The water consumption of the eco programme in liters per cycle: 45 l

Duration of eco 40-60 programme in hours and mins at rated capacity: 3:16 h

Spin-drying efficiency class of eco 40-60 programme: B

Airborne acoustical noise emission class: A

Airborne acoustical noise emissions : 66 dB(A) re 1 pW

Construction type: Built-in

Height of removable worktop: -2 mm

Dimensions of the product: 818 x 596 x 544 mm

Net weight: 75.8 kg

Connection rating: 2300 W

Fuse protection: 10 A

Voltage: 220-240 V

Frequency: 50 Hz

Approval certificates: CE, E17D UKCA marking, VDE

Length of electrical supply cord: 210 cm

Door hinge: Left

Wheels: No

EAN code: 4242005211470

Installation type: Full-integrated



Optional accessories

WMZ20441 : Height-adjustable feet

WMZ2200 : Floor securing component

WMZ2381 : Extension for cold water inlet /Aquastop



4 242005 211470

Serie | 8, Built-in washing machine, 8 kg, 1400 rpm WIW28501GB

**Especially quiet washing machine with
EcoSilence Drive and Silence program: enjoy
very quiet operation and excellent durability.**

Performance

- Energy Efficiency Class¹: C
- Energy² / Water³: 62 kWh / 45 litres
- Load capacity: 1 - 8 kg
- Programme duration⁴: 3:16 h:min
- Spin drying efficiency class: B
- Spin speed^{**}: 400 - 1400 rpm
- Noise level: 66 dB (A) re 1 pW
- Noise efficiency class: A

Programmes/functions

- Touch control buttons: Prewash, Ready in, Temperature selection, SpeedPerfect, start/pause with reload function, Aqua Plus, Spin speed reduction
- Special programmes: Drain / Spin, Down Wear, Dark Wash, Shirts, Sportswear, Mixed Load, Super Quick 15/30, Quiet Wash, Drum clean with reminder, Single Rinse, Wool/ Handwash, Standard cold - 40°C
- Safeguard monitoring system adjusts load distribution and programme settings to protect clothes

Key features

- Reload function: Flexibility to add or remove laundry items of any size even after start of the wash cycle.
- TimeLight: program status and remaining time clearly displayed on floor in high resolution.
- EcoSilence drive with 10 year warranty
- AntiVibration Design - for more stability and quietness
- ActiveWater Plus: for highly efficient use of water even with smaller loads thanks to automatic load detection.

Additional features

- Large display for programme progress indication, temperature, spin speed, remaining time, 24 hours end time delay and load recommendation
- Drum clean with reminder function
- AquaStop: Bosch home appliance with lifetime warranty against water damage*
- Foam detection system
- Detergent dispensing: easy clean
- Divider for Liquid Detergent
- Buzzer to indicate the end of cycle

Technical Information

- Fully integrated
- Large white door with 130° opening and 30 cm porthole
- Furniture door is reversible
- Dimensions (H X W X D): 81.8 x 59.6 x 57.4 cm
- Height adjustment with cardanDrive
- adjustable base height: 15 cm
- adjustable base depth: 6.5 cm

¹ Scale of Energy Efficiency Classes from A to G

² Energy consumption in kWh per 100 cycles (in programme Eco 40-60)

³ Weighted water consumption in litres per cycle (in programme Eco 40-60)

⁴ Duration of Eco 40-60 programme

^{**} Values are rounded.

**Serie | 8, Built-in washing machine, 8 kg,
1400 rpm
WIW28501GB**

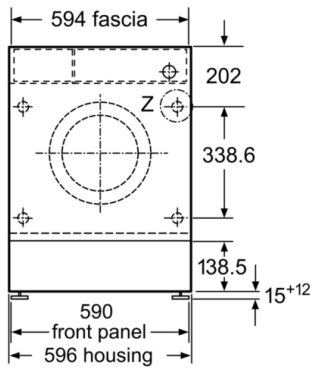

measurements in mm

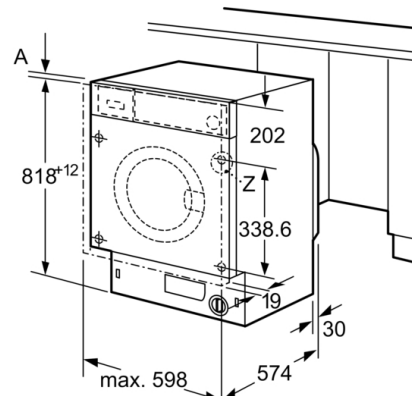

measurements in mm

Z detail

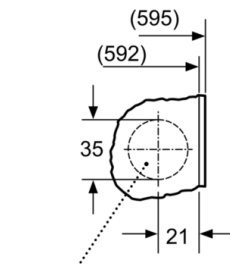

Hinge cup hole
min. 12 deep

measurements in mm

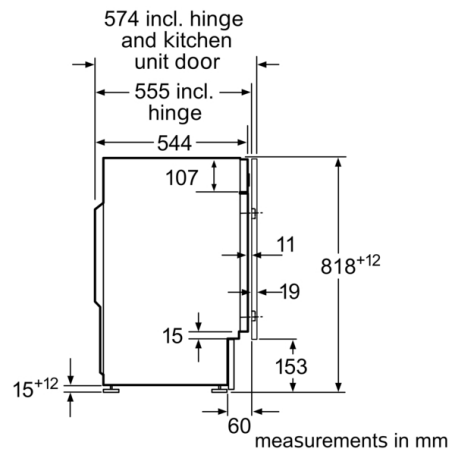

measurements in mm