

Dimensions

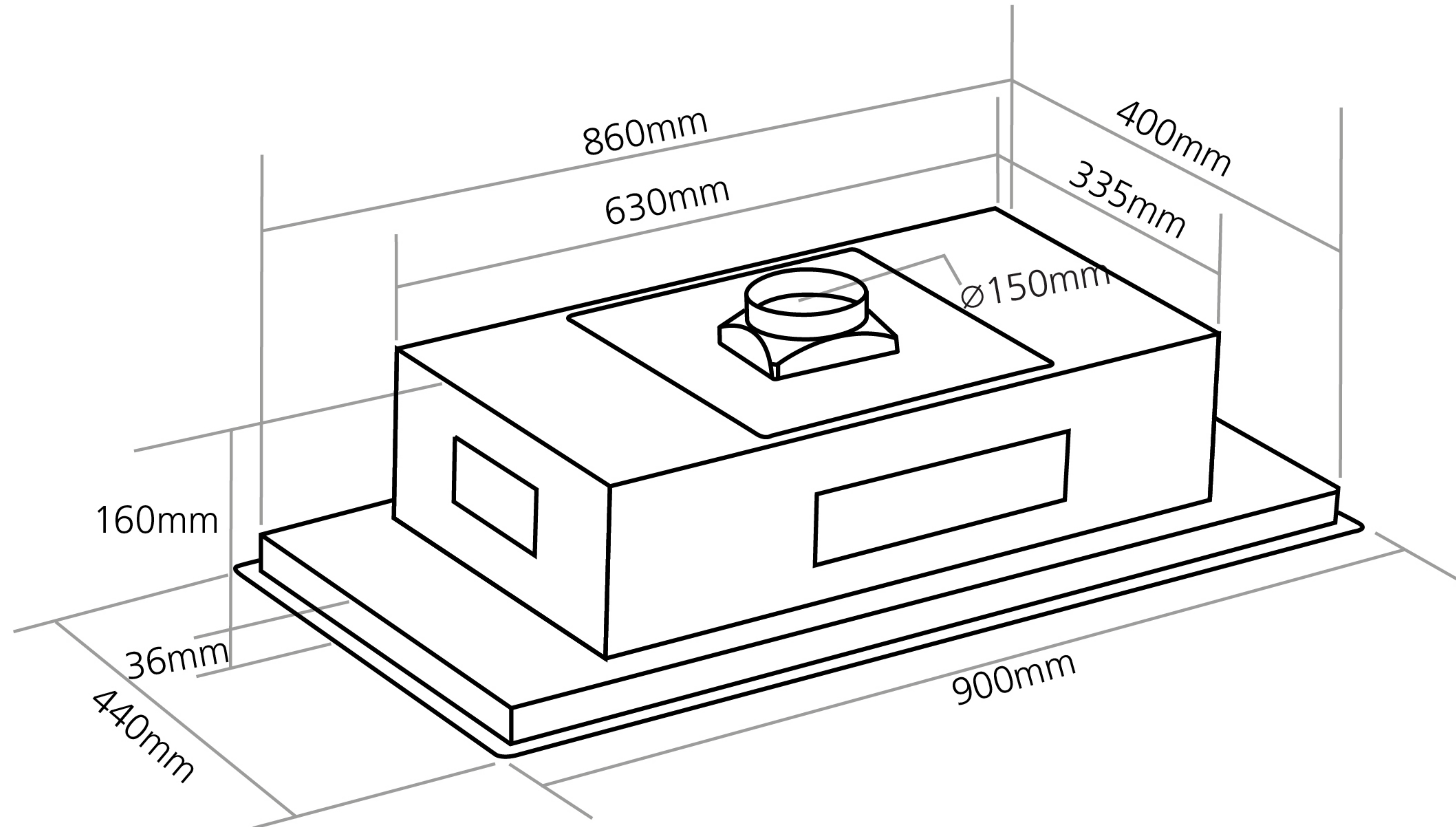

Minimum build in depth 270mm