

Product Finish: Chrome

Product code: AT1226
EAN13 barcode: 5060344151672



Product features:

- Metal construction throughout
- Quarter turn handle action for precise flow control
- Minimalist planate design form
- Antisplash spout supplied as standard
- Supplied complete with flexible tail pipes for fast simple fitting

Additional information / Parts included:

Includes 2.5 & 2mm Allen key & triangular stabiliser

Note: the image shown may not reflect the product finish, chrome finish is typically depicted.

Product dimensions:

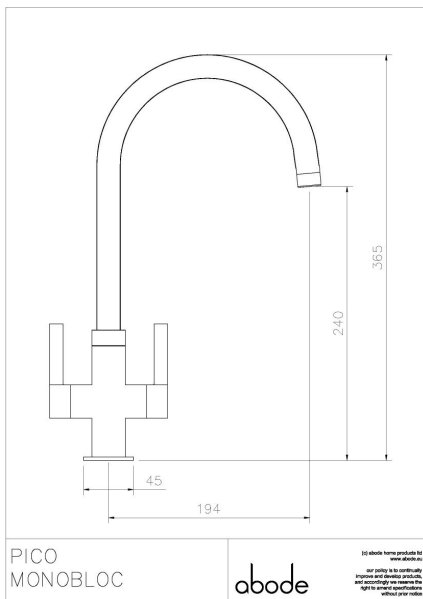

- Overall Height / projection: 365 mm
- Exit reach: 194 mm
- Exit height: 240 mm
- Centre distance(s):

- Base diameter(s): 45 mm
- Recommended hole diameter: Ø 35 mm
- Max. surface depth: 60 mm

- Spout diameter: 22 mm
- Spout aerator size: 22f

Packaged properties:

- Box length: 420mm
- Box width: 240mm
- Box depth: 75mm
- Units per outer: 5
- Tap only weight: 0.88kg
- Boxed weight: 1.46kg

Product flow characteristics:

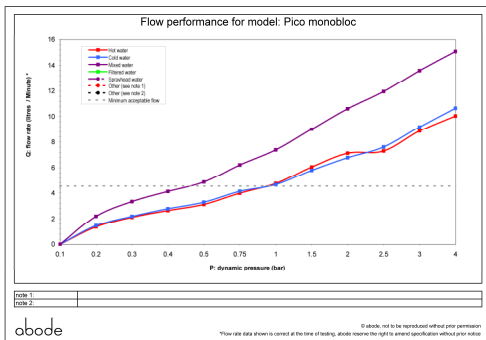

- Min / Max water pressure: 0.50 / 5.5 bar
- Recommended / Max water temperature: 46°C / 70°C
- Part G - Mixed flow rate at 3 bar (litres / min): 13.60

- Control valve type: Ceramic disc QT
- Product flow characteristics: Single flow
- Non return valve(s): Integral to hot & cold inlets

- Aerator type: Plastic mesh diffuser
- Accepts revolve / spray areator: Yes
- Spout connection method: Locking collar

- Tail pipe inlet / outlet size: M10 / 1/2" BSP Male
- Inlet pipe type / length: flexible stainless braided hose / 370 mm

Care instructions summary:

- Clean the mixers and showers regularly as required, using soap, do not use any other cleaners.
- Regular cleaning will prevent the build up of lime scale and dirt
- After cleaning rinse thoroughly with clean water to remove any cleaner residue
- Residues of sink & worktop cleaners can also cause damage, so rinse with clean water after using, avoid contact with any abrasives

Warranty Summary (Full details available on request):

- Materials and workmanship defects warranted for 5 years
- Valves and working parts warranted for 5 years
- Surface warranty defects warranted for 1 year
- O-rings, hoses & gaskets warranted for 1 year