

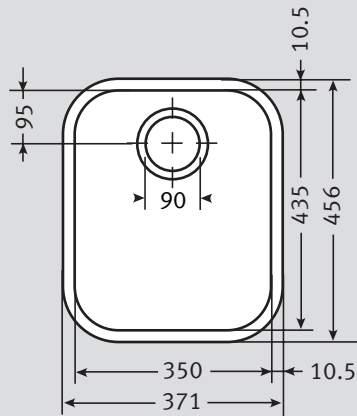

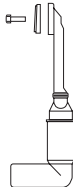

Ariane ARX 110 35 Specifications

- **1 x 90mm Waste with Basket Strainer Waste.** Capable of adaptation to take Waste Disposal Unit
- **Stainless Steel and 4 colours of bespoke accessories available**
- **Large Ariane bowl design**
- **Available as part of a Designer Pack**

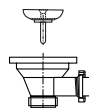
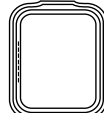

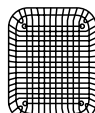
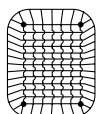
Material:	304 Austenitic 18/10 Stainless Steel	Waste:	1 x Lira 90mm Basket Strainer Waste with overflow	Overflow:	
Application:	Undermounted				
Bowl Size:	350 x 435 x 180	Accessories Available:			
Drainer Format:	N/A				
Cut-out Size:	Utilise template	Drainer Tray Available in White, Almond, Brown or Black	Drainer Tray Stainless Steel	Drainer Basket Available in White, Almond, Brown or Black	
Colour:	Silk Stainless Steel				
Seal:	Apply sealant locally	Drainer Basket Stainless Steel	Food Preparation Platter Iroko Large		
Insulation:	Grey Dynaphon for heat and sound	Cabinet Size:			
Heat Resistance:	Up to 300°C				
Earthing Point:	Supplied with sink	Fixing Clips:	Provided		
					
		Alternative fixing systems			
Suggested Plumbing Kit:	1 part				
		N.B. Cut out may not allow for accessories			
		Taps: Any Franke tap can be utilised with this model*.			
		*Ceramic disc taps in certain installations or where there is a low head of water (below 4 metres) may not provide adequate flow rates. You are advised to check with your supplier.			

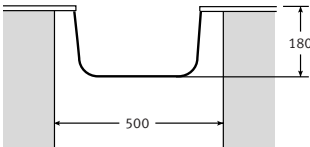
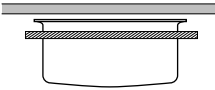
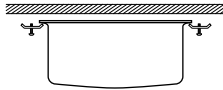
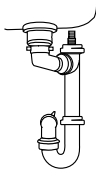
Guarantee: Franke sinks are guaranteed for 25 years against manufacturing defect. Franke taps are guaranteed against defective materials and workmanship for 1 year in relation to coatings and finishes, and 5 years in relation to moving parts. Franke will replace (and where appropriate repair) defective sinks. In relation to taps, Franke will where appropriate provide replacement parts for your taps or replace your taps. Any associated or ancillary costs to be incurred by you as a result of replacement of Franke sinks and taps under this guarantee shall in all cases be previously approved by Franke UK Limited. This guarantee is in addition to and does not affect your statutory rights.

The Franke policy is one of continued improvement, and Franke reserve the right to alter models and specifications without notice.